



Instruction manual

PH 3436

pH/REDOX TRANSMITTER
4-20 mA - RS485 - Modbus RTU

pH scale

0 ÷ 14.00 pH

ORP scales

0 ÷ 1000 mV

0 ÷ -1000 mV

-1000 ÷ 1000 mV

0 ÷ 2000 mV

0 ÷ -2000 mV

Temperature scales

-10.0 ÷ +100.0 °C

14.0 ÷ 230.0 °F

Option

S/N

REP N°

Power supply: 9 ÷ 36 Vdc

Installed firmware: R 3.0x



INDEX

1 - GENERAL WARNINGS AND INFORMATION FOR ALL USERS	3
1.1 Warranty	3
1.2 After sales service	3
1.3 CE marking	3
1.4 Safety warnings	3
1.5 Manual revisions	4
2 - PRODUCT OVERVIEW	5
2.1 Functional purpose of the device	5
2.2 Accessories	5
3 - INSTRUCTION MANUAL CONTENTS	6
3.1 Symbols	6
3.2 How to read the instruction manual	6
3.2.1 Using the instrument on the plant	7
3.2.2 Plant maintenance staff	7
3.2.3 Instrument installation	8
4 - SPECIFICATIONS AND TECHNICAL DATA	9
4.1 Functional specification	9
4.2 Technical data	12
4.2.1 General specifications	12
4.2.2 Technical specifications	13
5 - INSTALLATION	17
5.1 Packing list	17
5.2 Packing and unpacking	17
5.3 Storage and transport	17
5.4 Installation of the transmitter	17
5.5 Installation of the sensor	17
5.6 Electrical installation	18
5.6.1 Connection of the sensors	18
5.6.2 Connection of the temperature sensor	18
5.6.3 Connection of the current loop	19
5.6.4 Connection of the logic input	19
5.6.5 Connection to the RS485 serial port	19
5.6.6 Network connection (RS485)	19
5.7 Disposal	20
6 - OPERATING PROCEDURES	21

6.1	Operating principles	21
6.2	Display	22
6.3	Keys	22
6.4	Instruction for the user	23
6.4.1	Main measuring	23
6.4.2	Temperature measuring	23
6.4.3	Parameters reserved to the plant maintainer	24
6.4.4	Parameter reserved to the plant engineer	24
6.4.5	Information display	24
6.5	Instruction for the maintainer	24
6.5.1	Preliminary operations	24
6.5.2	Making measurements	25
6.5.3	pH calibration	25
6.5.4	ORP calibration	27
6.5.5	Temperature calibration	29
6.5.6	Setup	29
6.5.7	Maintenance of the transmitter	30
6.5.8	Maintenance of the sensor	30
6.6	Installation instruction	31
6.6.1	Safety requirements	31
6.6.2	Configuration	31
6.7	Operating modes	32
6.8	Analog mode	32
6.9	Digital operation	32
6.9.1	B&C communication protocol	33
6.9.2	Modbus protocol	46
7 - INSTALLATION DRAWINGS		54
<hr/>		
7.1	Connections	54
7.2	Dimensions	55
7.3	Analog mode wiring	56
7.4	Digital mode wiring	57
8 - WARRANTY		58
<hr/>		
9 - REPAIRS		58
<hr/>		

1 GENERAL WARNINGS AND INFORMATION FOR ALL USERS

1.1 WARRANTY

This product is guaranteed for 5 years from the date of purchase for all manufacturing defects.

Please take a look at the terms and conditions described on the warranty certificate at the end of the manual.

1.2 AFTER SALES SERVICE

B&C Electronics offers to all of its customers the following services:

- a free of charge technical assistance over the phone and email for problems regarding installation, calibration and regular maintenance;
- a repairing service in our Carnate (Italy) headquarter for all types of damages, calibration or for a scheduled maintenance.

Please take a look at the technical support data sheet at the end of the manual for more details.

1.3 CE MARKING

This instrument is manufactured according to the following european community directives:

- 2011/65/EU "Restriction of the use of certain hazardous substances in electrical and electronic equipment"
- 2014/30/EU "Electromagnetic compatibility" EMC

- EN 61326-1/2013 "Electromagnetic compatibility" EMC
 - Industrial electromagnetic environment
- EN 55011/2009 "Radio-frequency disturbance characteristics"
 - Class A (devices for usage in all establishment other than domestic)
 - Group 1 (Industrial equipment that do not exceed 9kHz)

The **CE** marking is placed on the packaging and on the S/N label of the instrument.

1.4 SAFETY WARNINGS

It is important to underline the fact that electronic instruments are subject to accidental failure. For this, it is important to take all necessary precautions to avoid damages caused by malfunctions.

Any operation must be performed by authorized and trained staff.

The use of this transmitter must comply with the parameters described in chapter "Technical data (page 12)", in order to avoid potential damages and a reduction of its operating life.

1.5 MANUAL REVISIONS

This chapter shortly describes the differences between previously released versions of the same manual, so to help users that are already familiar with the product.

Rev. B	Firmware R3.0 Modbus RTU function 06 and 16 ID+SN commands Bootloader function
Rev. A	Emission

2 PRODUCT OVERVIEW

2.1 FUNCTIONAL PURPOSE OF THE DEVICE

The system for monitoring pH or ORP consists of two main parts:

- the transmitter described in this instruction manual;
- the pH or ORP measuring electrode.

The instrument operates in analog and/or digital functionality (see chapter "Operating procedures (page 21)").

The transmitter performs the following functions:

- display of the pH or ORP values of the aqueous solutions, by using a suitable measuring electrode;
- display of the temperature values, by using a Pt100 temperature sensor;
- perform the manual or automatic temperature compensation;
- operate in analog or digital mode;
- transmit the data of the main measurement and of the temperature on the serial interface;
- connect to a master for remote configuration;
- activate the hold function of the current loop through an external free voltage contact.

2.2 ACCESSORIES

Sensors and accessories for different applications are available, to be ordered separately.

Our web site www.bc-electronics.it contains accessories, upgrades and detailed specifications of each product.

Our staff is always available to help costumers select the most appropriate and suitable solution for their specific needs.

3 INSTRUCTION MANUAL CONTENTS

This chapter describes the manual and gives suggestions to all users on how to read it and use it.

The manual is written according to the following norms:

- UNI 10893 "Instructions for use";
- UNI 10653 "Quality of product technical documentation".

The terminologies indicated in the international metrology vocabulary (VIM) are respected as far as possible.

3.1 SYMBOLS

Throughout the manual you may find the following symbols, which are both dictated by a norm or that are simply conventional.



WARNINGS: this symbol is used to warn users that if the instructions are ignored or not correctly followed, damage to the instrument can be caused.



NOTE: *this symbol is to invite the user to pay particular attention to a specific section of the manual.*

3.2 HOW TO READ THE INSTRUCTION MANUAL

The manual contains all the information needed to acquire full knowledge of the product, to ensure a proper installation, proper use and maintenance in order to achieve the desired result at the time of its choice.

The manual is aimed at staff with appropriate knowledge and experience in the field of measurement and control through the use of sensors and transmitters in the context of industrial plants and transmission of data.

The index of the manual refers the reader to the chapters on aspects that want to learn and develop.

In particular, the first chapters show general topics and allow the user to become familiar with the product, with its functional purpose and with the necessary accessories or options for its use.

The user can then check whether he is in possession of all the elements necessary for the use of the instrument, of the measurement / regulation chain and of the use of instruments connected to the network.

The instrument has been designed keeping in mind three different types of use: generic use (end user), control (maintenance staff), installation (plant engineer).

-  *The user normally can read the values on the display.
He will read the parts of the manual regarding the:
-"Instruction for the user (page 23)".*

Maintenance staff could be more interesting in the chapters regarding:

- "Instruction for the user (page 23)";*
- "Instruction for the maintainer (page 24)";*
- "Warranty (page 58)";*
- "Repairs (page 58)".*

The plant engineer will have to read the chapters and look at the application drawings in order to:

- verify that the technical and functional characteristics are conformed with the plants requirements;*
- verify that the environmental and climatic conditions required by the instruments are respected;*
- make the correct electronic connections;*
- become familiar with the instrument's firmware;*
- configure the instrument according to the application;*
- run all of the necessary tests before starting the instrument;*
- calibrate the instrument once the sensor is connected.*

-  *The data shown in the displays in this manual are only illustrative.*

3.2.1 USING THE INSTRUMENT ON THE PLANT

For the generic use, the end user can operate with a locked keyboard (suggested mode and to be set by maintenance staff). By this, he can check the set point parameters without the possibility of changing the configured set points values and the zero/sensitivity calibration.

3.2.2 PLANT MAINTENANCE STAFF

Maintenance staff can select the operating values, by setting the desired parameters of the setup menu and after inserting the password. He can also enable the user's access to calibration, set point and alarm settings.

The location of this set parameters can be seen in the left column of the technical specifications table and they are identified by a letter "S" followed by a number.

The operations that need to be done during the start-up and the periodical tests are the following:

- to allow only the visualization of the measures during the normal use;
- to calibrate the sensors by means of ZERO and SENS keys;
- to set the following parameters:
 - response time of the filter software;
 - temperature measuring unit (°C/°F);

- manual temperature compensation (only pH);
- to modify the password to access the setup.

3.2.3 INSTRUMENT INSTALLATION

The plant engineer, by inserting the access password and by setting and modifying the configuration parameters, will be able to select the necessary functions required by the plant.

The location of this set parameters can be seen in the left column of the technical specifications table and they are identified by a letter "C" followed by a number.

The operations that need to be done during the instrument installation are the following:

- pH/ORP electrode;
- ORP scale;
- baud rate of the RS485 interface;
- B&C or Modbus protocol ID;
- password to access the configuration.

4 SPECIFICATIONS AND TECHNICAL DATA

4.1 FUNCTIONAL SPECIFICATION

Display

The instrument is equipped with an alphanumeric LCD display 8x1 characters.

The display shows the measured values and messages which guide the operator in the use of the instrument.

The messages are alternating displayed.

Keyboard

The instrument has a 4 keys keyboard, which perform a dual function when pressed for more than 3 seconds allowing the access to all functions available. The combined pressure of a few buttons allows to perform additional functions described in specific points of the manual.

Inputs

The instrument is able to perform the measurement of the main parameter and temperature.

The pH value is measured by means of a glass electrode or antimony.

The ORP value is measured by a metal electrode/reference in three fields: positive, negative and negative + positive.

The temperature in °C or °F is measured by 3-wire RTD Pt100.

Scale

The instrument allows the user to select the pH scale and five scales in the field of redox positive, negative or both as indicated in the table in section "Technical data (page 12)".

Temperature compensation

The instrument displays the temperature value in the field $-10.0 \div 100.0$ °C or $14.0 \div 230.0$ °F and it performs the manual or automatic temperature compensation.

For absence or malfunction of the temperature sensor it automatically switches to manual compensation, by displaying the value of the compensation temperature.

Calibration

During the pH or ORP calibration, the instrument automatically recognizes standard solutions pH 4 - pH 7 - pH 9 and the standard ORP solution 220 mV.

If you use solutions other than standard, the instrument proposes the closer stored value allowing manual editing.

Analog output

The instrument operates in the current loop 4-20 mA proportional to the value of the principal measure.

The output is galvanically isolated, therefore directly interfaceable to a PLC, data acquisition cards or B&C Electronics instruments with 4/20 mA input.

Serial interface

Through the isolated RS485 interface, the user can connect the transmitter to a terminal or to a PC using a simple terminal emulation program. A RS485/RS232 or RS485/USB converter can be necessary.

Using B&C protocol, is possible measurements receiving, parameters setting and to calibration management.

Using Modbus protocol, functions 03, 06 and 16 are implemented for reading the measurements, changing the operating parameters and calibrating.

The MC 6587 and MC 7687 controllers from B&C Electronics allow complete management of the transmitter.

The bootloader function allows the firmware's update via serial port.

Software filter

A software filter with two selectable time constants operates on the input signal of the measuring cell.

The user can set the response time relative to the small or large variation signals separately, in order to obtain good reading stability and response speed to the variations of the measurement in the process.

Logic input

The instrument is equipped with a logic input which connects a free voltage contact from an external device.

The function of this input is to maintain in hold the current loop.

The state of the logic input is visible in the record digital broadcast.

Power supply

The instrument is powered (min. 9 Vdc ÷ max. 36 Vdc) through the current loop, directly from a PLC or data acquisition boards that provide the power, or by a power supply in series between the analog output and the apparatus of acquisition.

When operating in digital mode the instrument will be equally fed to the terminals of the current loop minimizing power consumption.

Setup

The instrument is provided with a setup menu protected by a specific password where you can:

- disable the calibration functions;
- choose the response time for the small/large software filter;
- select the unit of measurement of the temperature in °C or °F;
- change the access password.

In case the wrong password is entered, a message will appear and you can view the parameters but not modify them.

Configuration

The instrument is provided with a configuration menu protected by a specific password where you can select:

- the pH/ORP measuring;
- the type of pH sensor glass/antimony;
- the ORP scale;
- enabling the current loop;
- the baud rate of the RS485 interface;
- the ID for communication protocols Modbus or B&C;
- a new value of the access password.

In case the wrong password is entered, a message will appear and you can view the parameters but not modify them.

Information menu

The instrument is provided with an information menu to show:

- p/n and firmware release;
- last calibration date;
- total operating hours.

4.2 TECHNICAL DATA

4.2.1 GENERAL SPECIFICATIONS

Room temperature	0 °C ÷ +50 °C
Relative humidity	up to 95 % without condensation
Protection of transmitter	IP40
Weight	250 g
Dimensions	71 x 95 x 58 mm
Mounting	Rail din 4 modules
Display	LCD COG 8x1 characters
Characters dimensions	11.97 x 4.97 mm
Long messages	sent alternately (title + variable)
Connections	removable terminal blocks 3.5 mm pitch
Isolation in/out	500 Vdc
Immunity performance loss	< 1 % full scale
EMC/RFI conformity	EN61326
Registered design	002564666-001

4.2.2 TECHNICAL SPECIFICATIONS

In the left column indicates the number of the display concerned:

- SETUP parameters are indicated by "S xy"
- CONFIGURATION parameters are indicated with "C xy" where
x = paragraph y = sequential 1..2..3..4..ecc

1.0	MAIN MEASURING		Default
C1.1	Measuring type	pH / ORP	pH
	Sensor type		
C1.2A	• pH measuring	glass / antimony electrode	Glass
	• ORP measuring	ORP electrode	
	pH glass electrode	pH glass electrode	
	• Slope	59.16 mV / pH 25 °C	
1.1	• Potential at 7.00 pH	0.0 mV	
1.2	• Zero	± 2.00 pH	0.00 pH
	• Sensitivity	80 % ÷ 110 %	100 %
	• Calibration	man/auto with buffer solution BDH pH 4.00 / 7.00 / 9.00 20 °C	
	pH antimony electrode		
	• Slope	50 mV / pH 25 °C	
1.1	• Potential at 7.00 pH	-325.0 mV	
1.2	• Zero	± 2.00 pH	0.00 pH
	• Sensitivity	70 % ÷ 140 %	100 %
	• Calibration	man/auto con buffer solution BDH pH 4.00 / 7.00 / 9.00 20 °C	
	ORP electrode		
1.2	• Zero	± 100 mV	0 mV
1.2	• Sensitivity	80 % ÷ 110 %	100 %
	• Calibration	man/auto con buffer solution Mettler 220 mV	
	pH scale	0.00 ÷ 14.00 pH	
	Resolution	0.01 pH	
	Measure limits	-1.00 pH / 15.00 pH	
	Reading limits	-2.00 pH / 16.00 pH	

1.0 MAIN MEASURING		Default	
C1.2B	ORP scales	0 ÷ 1000 mV 0 ÷ -1000 mV -1000 ÷ 1000 mV 0 ÷ 2000 mV 0 ÷ -2000 mV	
	Resolution	1 mV	
	Measure limits	-2100 mV / 2100 mV	
	Reading limits	-2200 mV / 2200 mV	
S1.2	RT 90 % large signal	1 ÷ 20 seconds	2 s
S1.3	RT 90 % small signal	1 ÷ 20 seconds	10 s
	Measuring update	0.5 seconds	

2.0 SECONDARY MEASURING		Default	
D2.0	Measure	Temperature	
	Input	RTD Pt100 3 wires	
S2.1	Measuring unit	°C / °F	°C
	Temperature compensation	manual without RTD automatic with RTD	
	Scale	-10.0 ÷ 110.0 °C 14.0 ÷ 230.0 °F	
	Resolution	0.1 °C / °F	
	Zero	±5.0 °C ±9.0 °F	0.0 °C 0.0 °F
S2.2	Manual temperature	0.0 ÷ 100.0 °C 32.0 ÷ 212.0 °F	20.0 °C 68.0 °F

CURRENT LOOP		Default	
C5.1	Current loop	Enabled / Disabled	Enabled
	Current loop proportional to the measure	4-20 mA	
	Under range	3.80 mA	
	Over range	20.80 mA	

CURRENT LOOP		Default
ID of the selected scale (current loop enabled)		
• Scale pH	10 mA at switching on for 8"	
• Scale 1 ORP	11 mA at switching on for 8"	
• Scale 2 ORP	12 mA at switching on for 8"	
• Scale 3 ORP	13 mA at switching on for 8"	
• Scale 4 ORP	14 mA at switching on for 8"	
• Scale 5 ORP	15 mA at switching on for 8"	

DIGITAL FUNCTION		Default
Protocols		B&C protocol ASCII / Modbus RTU The two protocols can coexist
C8.2	B&C ID protocol	ID=01 ÷ 99 last s/n digit, if 0 ID=10
C8.3	Modbus address	ID=01 ÷ 243 last s/n digit, if 0 ID=10
The measuring and the parameters are sent after the receiving of the commands (see B&C ASCII and Modbus RTU function 03 - 06 - 16)		

SERIAL INTERFACE		Default
Interface		RS485 isolated not terminated
C8.1	Baud rate	2400 / 4800 / 9600 / 19200 baud
	Distance of connection	1000 / 500 / 250 / 125 m
Network		32 transmitters max

DIGITAL INPUT		Default
Input		from free voltage contacts 2 wires in closure
Digital function		hold on the 4-20 mA loop (The state of the input is visible on the digital protocols)

50.0	SETUP	Default
50.1	Password	000 ÷ 999
S1.1	Calibration interdiction	On / Off
S1.2	RT 90 % large signal	1 ÷ 20 seconds
S1.3	RT 90 % small signal	1 ÷ 20 seconds
S2.1	Temperature measuring unit	°C / °F

50.0 SETUP			Default
S2.2	Manual temperature	0 ÷ 100 °C 32 ÷ 212 °F	20 °C
S50.1	Password changing	000 ÷ 999	000

60.0 CONFIGURATION			Default
60.1	Password	000 ÷ 999	000
C1.1	Type of measuring	pH / ORP	pH
C1.2a	pH sensor	Glass / Antimony	Glass
C1.2b	ORP scale	0 ÷ 1000 mV	0 ÷ 1000 mV
		0 ÷ -1000 mV	
		-1000 ÷ 1000 mV	
		0 ÷ 2000 mV	
		0 ÷ -2000 mV	
C5.1	Current loop	Enabled / Disabled	Enabled
C8.1	Baud rate	2400 / 4800 / 9600 / 19200 baud	9600 baud
C8.2	B&C ID protocol	ID=01 ÷ 99 last s/n digit, if 0 ID=10	01 ÷ 10
C8.3	Modbus address	ID=01 ÷ 243 last s/n digit, if 0 ID=10	01 ÷ 10
C60.1	Password changing	000 ÷ 999	000

70.0 INFO MENU			Default
I1.0	P/N and firmware release	PH3436 Rev3.xx	
I2.0	Last calibration date	XX/XX/XX	00/00/00
I3.0	Total operation hours	XXXXXXX h	

POWER SUPPLY			Default
	Power supply	min. 9 Vdc / max. 36 Vdc	
	Current - current loop enabled	4-20 mA, 21 mA max	
	Current - current loop disabled	4 mA at 9 Vdc (with no communication)	
	The current value can be higher during the receiving the commands and the answer in a serial communication.		

5 INSTALLATION

5.1 PACKING LIST

The package contains:

- N° 1 unit with serial number label;
- N° 1 instruction manual.

5.2 PACKING AND UNPACKING

- 1 Open the carton box and keep it.
- 2 Remove the instrument for the carton box.
- 3 Remove the plastic protection from the instrument.

If repackaging do the reverse.

5.3 STORAGE AND TRANSPORT

For prolonged storage, keep the product in dry places.

In case of transportation, pack the product in a carton box.

5.4 INSTALLATION OF THE TRANSMITTER

The instrument can be installed in a watertight box or in an electrical control panel with a DIN rail.

5.5 INSTALLATION OF THE SENSOR

Follow the instructions for installation of submersible pressure or flow.

The submersible B&C Electronics probe contains the sensor (also called electrode) and is equipped with a ring to adjust the depth of immersion in the test liquid.

Secure the probe to the tank by a bracket with a hole of about 36 mm.

The installation of the sensors by means of holders in the flow (for example the models of B&C Electronics SZ 7101 - SZ 7105 - SZ 7108) must be carried out keeping the sensor oriented downwards, with a maximum inclination of 45° to the vertical.

Protect the coax cable of the sensor by rain or corrosive agents, for example through a sheath.

The interruption of the coax cable can cause disturbances to the measure, therefore, is not recommended.

In case of need of cable extension, use terminal strips with high insulation and protected from moisture (for example the accessory derivation SZ 740).

Keep the shielded cable of the sensor away from the power cables.

5.6 ELECTRICAL INSTALLATION

For all electrical connections, refer to the label on the instruments, also shown and described in chapter "Installation drawings (page 54)".

All the connections to the instrument are made using removable terminal blocks.

-  It should be remembered that the electronic instruments are subject to accidental failure.
Predict the necessary precautions to avoid any damage caused by their dysfunction.

5.6.1 CONNECTION OF THE SENSORS

The connection of the electrodes is the most critical part of the whole system.

The pH and ORP electrodes are connected to the central wire of the respective coaxial cable.

The reference electrodes are connected to the shield of the respective coaxial cable.

- Connect the central of the coaxial cable to the 17 high impedance terminal marked HI.
- Connect the shield of the coaxial cable to the 16 low impedance terminal marked LO.

Use only the original coax cables supplied by the manufacturer in between sensor and input terminals of the instrument.

-  The coax cable generally has a conductive sheath, very thin, between the central conductor and the shield. Remove this sheath for at least 5 mm in order to avoid the contact with the fastening terminal of the central conductor.

5.6.2 CONNECTION OF THE TEMPERATURE SENSOR

To display the temperature value and for the automatic compensation of the effect of temperature on the pH measurement is necessary to connect the temperature sensor Pt100 RTD as shown in chapter "Installation drawings (page 54)", using the appropriate wire section.

If the temperature sensor is not connected, or is interrupted or in short circuit, the instrument automatically switches to the manual temperature compensation.

Two-wire PT100 connection for short distances

- Connect the Pt100 to terminals 13-14 (marked T1-T2) and short terminals 14-15 (marked T2-T0).

Three wire Pt100 connection for great distances

- Connect a Pt100 wire to the terminal 13 marked T1.
- Connect one common wire of the Pt100 to terminal 14 (marked T2) and the other common wire to terminal 15 (marked T0) using two separate wires.

-  Do not interrupt the connection cable.
Use extension cable through high isolation junction box;
Keep the cable away from the power cables.

5.6.3 CONNECTION OF THE CURRENT LOOP

The instrument provides an output current proportional to the primary measure to drive an external recorder, PLC or other similar devices.

- Connect the (+) terminal of the power supply to the terminal 3 marked +.
- Connect the return of the loop (-) to the terminal 2 marked -.

If the analog signal must drive more devices, they must be connected in "series" with each other, respecting the maximum value of resistance as a function of the supply voltage.

5.6.4 CONNECTION OF THE LOGIC INPUT

The free voltage contacts in closure from an external device must be applied to the logic input terminals 7 and 8 marked GND and DI.

-  Do not give any power to the logic input terminals.

5.6.5 CONNECTION TO THE RS485 SERIAL PORT

The instrument can be configured as a slave device and communicate via the serial port. There are two types of protocol as described in chapter "Digital operation (page 32)".

- Connect the positive differential of the RS485 interface to terminal 5 marked A+.
- Connect the negative differential of the RS485 interface to terminal 6 marked B-.
- Connect the eventual ground of the RS485 interface to terminal 7 marked GND.

5.6.6 NETWORK CONNECTION (RS485)

These digital transmitters use a RS485 driver with slow switching fronts.

This implies that it is not necessary to complete the termination of the transmission line even for long distances.

The following directions are to be considered as examples.

If the driver of the master device has very fast switching fronts, it may be necessary to terminate the beginning and end of the transmission line.

In this case it should be inserted in the transmission line an AC termination by inserting a capacitor in series with the terminating resistor at the beginning and end of the transmission line.

The purely resistive termination is not tolerated by the transmitter as the internal power supply does not support high loads.

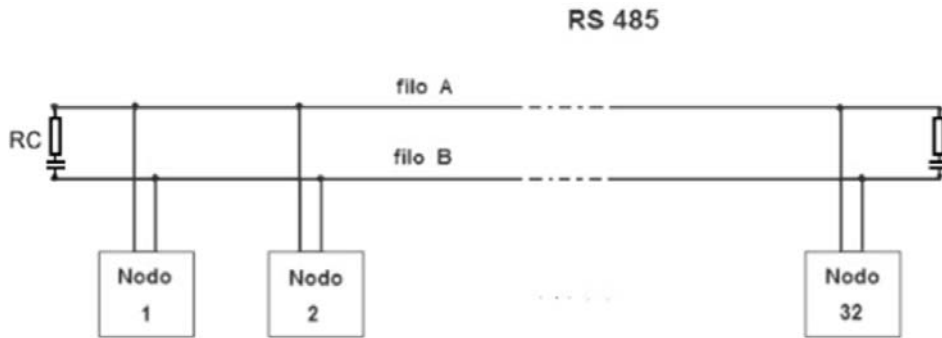

By way of example, the value of the capacitor will have the following values depending on the length of the line: 10 nF (150 m) - 22nF (300 m) - 47 nF (600 m) - 100 nF (1000 m).

5.7 DISPOSAL

In case of disposal of the instrument, apply the terms of the law provided for the disposal of electronic devices.

6 OPERATING PROCEDURES

6.1 OPERATING PRINCIPLES

When measuring pH the instrument receives a signal in mV from the sensor and provides the value in pH units, according to the Nernst's law.

In case of ORP measuring the instrument receives a mV signal from the sensor and provides the value in mV.

In both cases the user can adjust the zero and the sensitivity to compensate for changes in sensor response due to the conditions of use.

The temperature affects the activity of the ionic solution and the signal provided by the sensor.



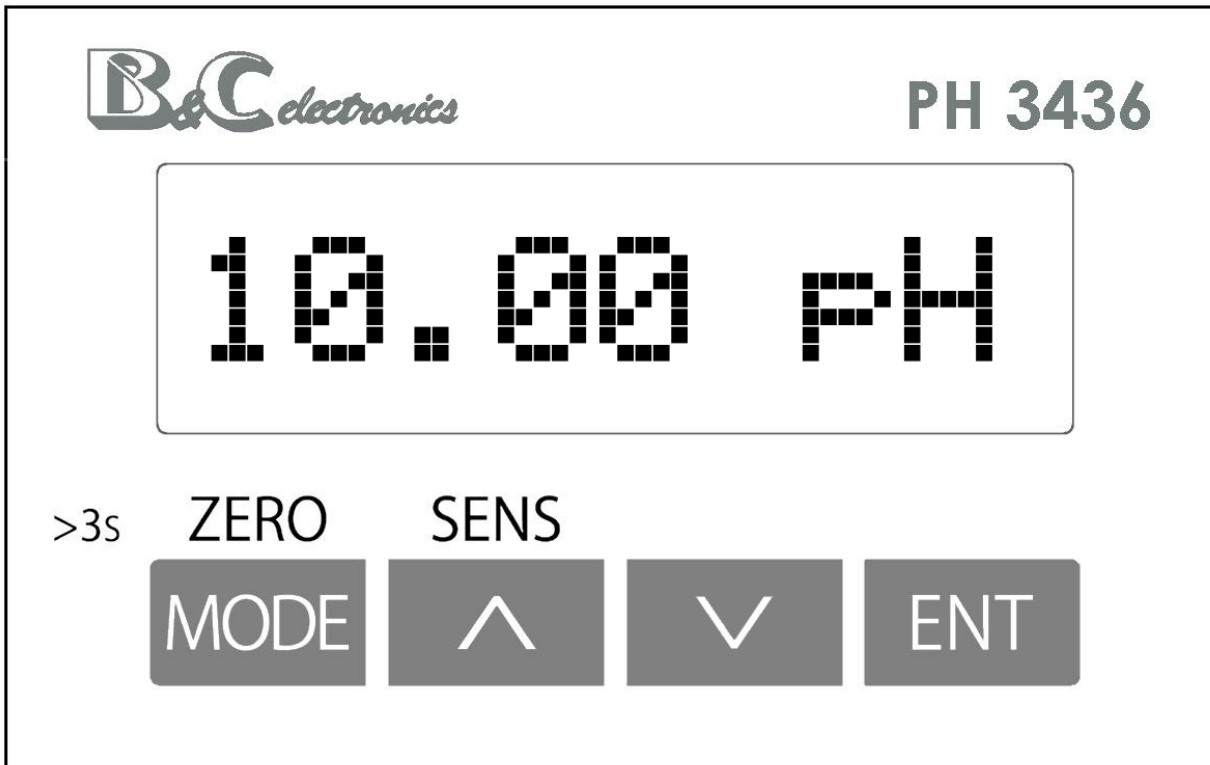

For this reason, in the pH measuring it is necessary to use the temperature compensation in applications where the temperature of the liquid is significantly different from the reference value of 20 °C.

The user needs to evaluate the installation of a Pt100 in order to perform the automatic compensation in case the temperature undergoes large changes.

6.2 DISPLAY



6.3 KEYS

KEY	FUNCTION
<p>ZERO</p> 	<p>Key MODE/ZERO</p> <ul style="list-style-type: none"> - Visualize the sequence of the functions - Exit without changing the visualized value - >3s Start the zero calibration
<p>SENS</p> 	<p>Key UP/SENS</p> <ul style="list-style-type: none"> - Increase the value - Access to the parameter changing - >3s Start the sensitivity calibration
	<p>Key DOWN</p> <ul style="list-style-type: none"> - Decrease the value - Access to the parameter changing
	<p>Key ENTER</p> <ul style="list-style-type: none"> - Confirm the visualized value - Go to the next parameter (in setup and configuration) - Access to the secondary menu and parameters - >3s Activate and deactivate the hold function

6.4 INSTRUCTION FOR THE USER

6.4.1 MAIN MEASURING

The display shows the value of the main measure as selected in the configuration menu.
pH measuring



ORP measuring



If the values are below/above the limits of reading will be shown respectively the messages -<<<< and >>>>.

Approaching the limits of measurement will be displayed alternately the reading and the value of the output current.

From the main measurement display 1.0 the user can access the calibration procedures, if they have not been reserved to the maintainer.

ENT to visualise the current value of the analog output.

6.4.2 TEMPERATURE MEASURING

The display shows the value of the temperature measurement (real or set), the measuring unit (*C or *F) and M in case of absence of the temperature probe.

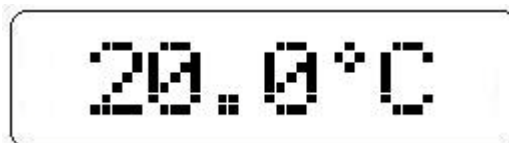

From this display the user can access the calibration procedure of the temperature probe, if this has not been reserved to the maintainer.

6.4.3 PARAMETERS RESERVED TO THE PLANT MAINTAINER

From this display the user can access the maintenance menu of the instrument (setup) via password.



6.4.4 PARAMETER RESERVED TO THE PLANT ENGINEER

From this display the user can access the installation menu of the instrument (configuration) via password.

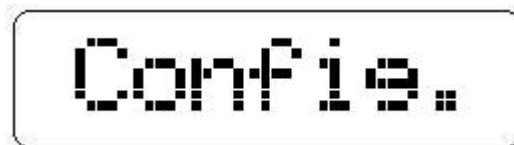

6.4.5 INFORMATION DISPLAY

From this display the user can access the information of the instrument.



- ENT - to access to the functioning informations
 - to set/visualize the last calibration date
 - to visualize the total hours of operation
- MODE to go to the measuring display.

6.5 INSTRUCTION FOR THE MAINTAINER

6.5.1 PRELIMINARY OPERATIONS

Any checking operation must be done with the electrode or an adequate simulator connected to the input of the device.

If a simulator is not available, it is possible to short the input terminals to simulate the values pH=7 or mV=0.

In particular, check that the instrument has been properly configured for the type of use.

To verify the parameters without modifying them follow the operating procedures described in paragraph "Setup (page 29)".

The display provides all the information necessary for the preliminary checks of operation.

The lighting of the display indicates that the unit has power and power circuits are working properly.

6.5.2 MAKING MEASUREMENTS

To operate the system installed, verify the connection of the following components:

- the pH/ORP sensor and the eventual RTD in contact with the liquid under test;
- the logic input if necessary.

Provide the power to the current loop and read the pH or ORP value of the liquid under test.

If the sensors are connected properly, as described in chapter "Installation drawings (page 54)", the system will operate on a regular basis and require only the calibration.

6.5.3 PH CALIBRATION

Before calibrating check that the glass membrane of the sensor was kept moist during storage.

If the protective reservoir or cap of the glass membrane is dry, immerse the electrode in a buffer solution or in tap water (do not use distilled water) for at least three hours before proceeding.

In any case, follow the instructions of the manufacturer of the electrode.

To make the standardization of the pH electrode (calibration) the operator can use the standard solutions from B&C Electronics. The instrument automatically recognizes the buffer solutions through the table pH/ °C stored in it. The operator must check the value proposed and eventually modify it in accordance with the actual value of the buffer solution used.

Zero calibration

Soak the electrode in pH=7 solution (SZ 954) to calibrate the 1st point (zero calibration).

MODE (ZERO) by pressing this button for more than 3 seconds, the message **Zero Cal** appears alternately to the actual pH value or **Cal lock** if the calibration was inhibited in the setup (Display S1.1).

UP/DOWN to modify the pH value.

If the measured value is close to that of the buffer solution, the value stored will be proposed.

The display will show the measured value **xx.xx pH**.

UP/DOWN to modify the value.

ENT to confirm the new value.

If the new value exceeds the limits of acceptability shown in the technical specifications of the instrument, the error **Zero err** will appear.

ENT to delete the error message and return to the main display.

If the new value is accepted, the display will show for a few seconds the message **UP-DATE**.

 *The reset to zero factory in the main display is done as follows: start the calibration of zero, simultaneously press the UP, DOWN and ENT; the message **RES Zero** will appear for a few seconds.*

Sensitivity calibration

Soak the electrode in pH=4 (SZ 952) or pH=9.21 (SZ 956) solutions to calibrate the 2nd point (calibration of sensitivity).

- UP (SENS) by pressing this button for more than 3 seconds, the message **Sens Cal** will appear alternately to the actual pH value or **Cal lock** if the calibration was inhibited in the setup (Display S1.1). Wait for the stabilization of the value.
- UP/DOWN to modify the pH value.

If the measured value is close to that of the buffer solution, the value stored will be proposed.

The display will show the measured value **xx.xx pH**.

- UP/DOWN to modify the value.
- ENT to confirm the entered value.
- MODE to return to the main display without entering the sensitivity.

If the new value exceeds the limits of acceptability shown in the technical specifications of the instrument, the error **Sens err** will appear.

- ENT to delete the error message and return to the main display.

If the new value is accepted, the display will show for a few seconds the message **UP-DATE**.

 *The reset to sensitivity factory in the main display is done as follows: start the calibration of sensitivity, simultaneously press the UP, DOWN and ENT; the message **RES Sens** will appear for a few seconds.*

One point calibration

In some cases it may be considered sufficient to perform the one point calibration with a buffer solution of value close to the process value.

In this case follow the zero calibration procedure.

Error messages

The error messages during the calibration inform the user that the pH electrode is in operating condition unacceptable (and therefore risky for the plant).

In fact a deviation of the zero > 2 pH is indicative of excessive pollution of the reference electrode.

A deviation of sensitivity < 80 % or > 110 % indicates electrode exhausted or losses in connection cable.

In case of these reports is advisable to replace the electrode.



If the value is different from that expected may mean that:

- the real value of the buffer used is very different from the nominal one (the solution is polluted or altered);
- the electrode is not operating normally (broken, badly installed).

The calibration of the pH meter in case of temperature compensation requires special precautions:

- consider the value of pH of the buffer at the operating temperature;
- detect the value of the temperature of the solution;
- wait for the stabilization of the temperature measurement.

6.5.4 ORP CALIBRATION

In general it is preferable to work with the factory calibration with which the instrument measures the actual mV values supplied by the electrode of redox.

Should calibration be necessary, it is advisable to carry out the zero calibration only.

If the protective reservoir or cap of the glass membrane is dry, immerse the electrode in a buffer solution or in tap water (do not use distilled water) for at least three hours before proceeding.

In any case, follow the instructions of the manufacturer of the electrode.

To make the standardization of the ORP electrode (calibration) the operator can use the standard solutions from B&C Electronics SZ 961 (220 mV).

Zero calibration

Soak the electrode in the solution to calibrate the 1st point (zero calibration).

MODE (ZERO) by pressing this button for more than 3 seconds, the message **Zero Cal** appears alternately to the actual ORP value or **Cal lock** if the calibration was inhibited in the setup (Display S1.1).

UP/DOWN to modify the value.

If the measured value is close to that of the buffer solution, the value stored will be proposed.

The display will show the measured value **xxxxx mV**.

UP/DOWN to modify the value.

ENT to confirm the new value.

If the new value exceeds the limits of acceptability shown in the technical specifications of the instrument, the error **Zero err** will appear.

ENT to delete the error message and return to the main display.

If the new value is accepted, the display will show for a few seconds the message **UP-DATE**.

 *The reset to zero factory in the main display is done as follows: start the calibration of zero, simultaneously press the UP, DOWN and ENT; the message **RES Zero** will appear for a few seconds.*

Sensitivity calibration (only if necessary)

If it is necessary to perform the sensitivity calibration, soak the electrode in the second buffer solution.

- | | |
|-----------|--|
| UP (SENS) | by pressing this button for more than 3 seconds, the message Sens Cal will appear alternately to the actual ORP value or Cal lock if the calibration was inhibited in the setup (Display S1.1). Wait for the stabilization of the value. |
| UP/DOWN | to change the ORP value. |

If the measured value is close to that of the buffer solution, the value stored will be proposed.

The display will show the measured value **xxxxx mV**.

- | | |
|---------|---------------------------|
| UP/DOWN | to modify the value. |
| ENT | to confirm the new value. |

If the new value exceeds the limits of acceptability shown in the technical specifications of the instrument, the error **Sens err** will appear.

- | | |
|-----|---|
| ENT | to delete the error message and return to the main display. |
|-----|---|

If the new value is accepted, the display will show for a few seconds the message **UP-DATE**.

 *The reset to sensitivity factory in the main display is done as follows: start the calibration of sensitivity, simultaneously press the UP, DOWN and ENT; the message **RES Sens** will appear for a few seconds.*

Error messages

The error messages during the calibration inform the user that the ORP electrode is in operating condition unacceptable (and therefore risky for the plant).

In fact a deviation of the zero > 100 mV (**Zero Err**) is indicative of excessive pollution of the reference electrode.

A deviation of sensitivity < 70 % or > 140 % (**Sens Err**) indicates electrode exhausted or losses in connection cable.

In the case of these reports is advisable to replace the electrode.



- If the value is different from that expected may mean that:
- the real value of the buffer used is very different from the nominal one (the solution is polluted or altered);
 - the electrode is not operating normally (broken, badly installed).

6.5.5 TEMPERATURE CALIBRATION

It can be made when the Pt100 sensor is connected.

Immerse the Pt100 in a liquid or keep the sensor in the air knowing the value of the temperature.

- MODE press the key from the main display to go to D2.0 display.
- MODE (ZERO) press the key for more than 3 seconds, The message **Zero Cal** will appear alternately with the temperature value.

Wait for the stabilization of the temperature value on the display.

- UP/DOWN to modify the value.

The display will show the actual value **XXX.X °C o °F**.

- UP/DOWN to modify the value.
- ENT to confirm the entered value.
- MODE to return to the main display without modify the values.

The message **Update** indicates the calibration is memorized.

If the new value exceeds the limits shown in the specification, the message **Zero err** will appear.



*The reset to factory value in the main display is done as follows: start the calibration of temperature, simultaneously press the UP, DOWN and ENT; the message **RES Zero** will appear for a few seconds.*

6.5.6 SETUP

- MODE press the key two times from 1.0 display to get the message Set-up (display 50.0).
- ENT to scroll through the setup functions.
- UP/DOWN to change the value or the option visualized on the display.
- ENT to confirm the changings; the message UPDATE will appear.
- MODE to exit form the procedure and to turn to the 50.0 display.

Display	Contents	Meaning	Possible values
50.1	PASS 000	Password to access the setup menu	000 ÷ 999
S1.1	Cal lock	Inhibition of the zero and sensitivity calibration	On Off
S1.2	RT large	Response time of the large filter software	1 ÷ 20 s
S1.3	RT small	Response time of the small filter software	1 ÷ 20 s
S2.1	T Unit	Measuring unit of the temperature	°C °F
S2.2	T man	Manual temperature values	0.0 ÷ 100.0 °C 32.0 ÷ 212.0 °F
S50.0	Set-up	Password setting	000 ÷ 999

 If the password is incorrect, the message "**WRONG PW**" will appear for 2 seconds and you can view the parameters but not modify them.

6.5.7 MAINTENANCE OF THE TRANSMITTER

The use of electronic components of high quality gives the instrument characteristics of great reliability.

The frequency of any maintenance depends on the particular use of the instrument.

-  **WARNING:** Disconnect the power supply to the unit before performing the following procedures:
- dust removal from the terminal;
 - operations on the wires connecting the terminal;
 - mounting of the instrument in the switch board.

As with any electronic device mechanical components such as buttons and terminal blocks, are the most prone to failure.

- Periodically check that the device is not subject to excessive moisture.
- Check that the connections to the terminal are free of dust and corrosion.
- Check that the terminal screws are tight.

6.5.8 MAINTENANCE OF THE SENSOR

The instrument can provide incorrect measurements due to the sensor which must be carried out proper maintenance by following the instructions in its specific manual.

The electrodes must be inspected and cleaned regularly, most frequently in the case of applications in alkaline liquids or fat-containing or organic substances.

Periodically, according to the needs of the application, it is suggested to perform the calibration operations.

In case of no use for long periods, store the electrode with the protective reservoir or cap containing a storage liquid if available, or tap water.

Do not use distilled water.

6.6 INSTALLATION INSTRUCTION

6.6.1 SAFETY REQUIREMENTS

 After performing the installation (chapter "Installation (page 17)"), before switching on and configuring the instrument do the following operations:

- check that all connections are correct;
- check that all connections are fastened on the terminal;
- check that the mechanical attachment of the cables does not cause any twisting or bending on the terminal blocks.

 **WARNINGS:** The damage due to incorrect connections during installation are not covered by warranty.

6.6.2 CONFIGURATION

MODE	press the key three times from 1.0 display to get the message Config. (display 60.0).
ENT	to scroll through the configuration parameters.
UP/DOWN	to change the value or the option visualized on the display.
ENT	to confirm the changings; the message UPDATE will appear.
MODE	to exit form the procedure and to turn to the 60.0 display.

 *Depending on the configuration of the instrument configuration parameters may not be displayed.*

Display	Contents	Meaning	Possible values
60.1	PASS 000	Password to access the configuration menu	000 ÷ 999
C1.1	Sensor	Selection of the sensor type	pH ORP
C1.2a	pH	Selection of the pH electrode type	Glass Antimony
C1.2b	ORPscale	Selection of the ORP scale	0 ÷ 1000 mV 0 ÷ -1000 mV -1000 ÷ 1000 mV 0 ÷ 2000 mV 0 ÷ -2000 mV
C5.1	Loop	Current loop enable/disable	enable disable
C8.1	BaudRate	Selection of the baud rate	2400/4800 9600/19200
C8.2	B&C ID	ID for the B&C protocol	01 ÷ 99

Display	Contents	Meaning	Possible values
C8.3	ModbusID	ID for the Modbus protocol	01 ÷ 243
C60.0	Config.	Password setting	000 ÷ 999

 *If the password is incorrect, the message "WRONG PW" will appear for 2 seconds and you can view the parameters but not modify them.*

6.7 OPERATING MODES

The transmitter can be configured to operate in analog mode (current loop 4-20 mA = enable). The digital mode is always active.

 *In order to reduce the power consumption, the user can disable the current loop and operate only in digital mode.*

6.8 ANALOG MODE

In analogue mode the transmitter provides a 4-20 mA output current loop isolated from the sample for direct connection to a PLC or to a data logger.

The transmitter can be connected to a PLC or instruments BC 7335 - BC 7635 - BC 7687 - BC 6587 B&C Electronics, which allow the visualization of the measure and have two set point on/off and a min/max alarm.

In analogue mode the instrument maintains the operation in digital mode.

The transmitter is supplied with the factory configuration in analogue mode (loop = enable).

When switched on the transmitter will provide for 8 seconds a current value that allow the operator to identify the scale of measurement selected in the configuration:

- 10 mA for pH scale;
- 11 mA for 0 ÷ 1000 mV scale;
- 12 mA for 0 ÷ -1000 mV scale;
- 13 mA for -1000 ÷ 1000 mV scale;
- 14 mA for 0 ÷ 2000 mV scale;
- 15 mA for 0 ÷ -2000 mV scale.

6.9 DIGITAL OPERATION

In digital mode the transmitter is a slave device that interacts with a master device.

Through the RS485 interface the transmitter can be connected to a master device.

To connect to a PC a RS485/RS232 or RS485/USB converter (like B&C Electronics' BC 8701) can be required.

The communication takes place via the RS485 connection with the B&C protocol (ASCII) and Modbus RTU (function 03, 06, 16) protocol described in the following chapters.

The transmitter can be connected to the MC 7687 - MC 6587 B&C Electronics controllers, which provide power supply, perform remote display and adjustment functions and allow complete management of the transmitter itself.

6.9.1 B&C COMMUNICATION PROTOCOL

Connect the transmitter to a PC for data management and calibration, using a simple terminal emulation program (example Hyperteminal).

Mode of transmission

Code system	ASCII
Number of bits per character:	
- start bits	1
- data bits	8
- parity	no parity
- stop bits	1
Error check (only A command)	BCC
Speed	9600 baud (default)

Command format using ID (01 ÷ 99)

1 or 2 byte ID transmitter (01 ÷ 99)

1 or 2 byte of command

n byte to be inserted if required by the command

1 byte <cr> (carriage return) end command

The transmitter transmits only if the ID sent is correct or is 00.

 Do not use 00 ID if more than one transmitter is connected, to avoid overlap of the communication.

Command format using ID + SNxxxxxx

1 or 2 byte ID transmitter (01 ÷ 99)

8 byte serial number (SNxxxxxx)

1 or 2 byte of command

n byte to be inserted if required by the command

1 byte <cr> (carriage return) end command

The transmitter transmits only if the ID + serial number sent is correct or if it is 00 + serial number.

 If the communication port is set to a different speed the transmitter will not communicate.

 *All the available commands are listed in the following pages.*

 *The list of commands implemented in the transmitter is always available by sending the command Help.*

COMMANDS USING ID

HELP

Command format: ID + H <cr>

Example: if ID=14 type 14H <cr> or 00H <cr>

By sending the command H displays the list of available commands with a brief description of their meaning.

Example of the HELP menu with the pH scale configured

```
-----
HELP MENU, COMMAND LIST          B&C ELECTRONICS
-----
PH3436 pH/ORP TRANSMITTER Rev.fw:3.00 S/N:160589

00H <cr> Help menu
00A <cr> Acquisition
00Lx <cr> Current loop:          0001          (0=disable 1=enable)
00Kx <cr> Sensor type:          0001          (1=pH Glass 2=pH Antim. 3=ORP)
00RLx<cr> RT90% large signal 0002 s          (1-20s)
00RSx<cr> RT90% small signal 0010 s          (1-20s)
00Wx <cr> Temp. unit            0001          (1=°C 2=°F)
00Jx <cr> Temp. adjust          not done      0.0          (5.0°C/9.0°F max) (00JR reset)
00Nx <cr> Tman                  20.0 °C          (0.0-100.0°C / 32.0-212.0°F)
00Vx <cr> Standard zero pH:     0.00 pH          (0.00-14.00 pH)
00Tx <cr> Standard sens.pH:     0.00 pH          (0.00-14.00 pH)
00Z <cr> Zero calibration: not done 0.00          (2.00 pH max) (00ZR reset zero)
00S <cr> Sens. calibration: not done 100.0%          (80-110%) (00SR reset sens)
00Dx <cr> Last cal date:        00/00/00          (XX/XX/XX XX=00-99)
00Ix <cr> ID B&C:                0009          (01-99)
00Ex <cr> ID modbus:            0009          (01-243)
00Bx <cr> Baud rate:            0003          (1=2400 2=4800 3=9600 4=19200)

Type ID number or 00 before command. Example, if ID=15 type 15A or 00A <cr>
Use 00A <cr> if only one probe is connected
Query commands: 00H?,00Z?,00S?,00J?
-----
```

The HELP menu with the electrode of antimony is as above with the only variant in the acceptance limits of sensitivity.

Example of HELP menu with the ORP scale configured

```

-----
HELP MENU, COMMAND LIST          B&C ELECTRONICS
-----
PH3436 pH/ORP TRANSMITTER Rev.fw:3.00  S/N:160589

00H <cr> Help menu
00A <cr> Acquisition
00Lx <cr> Current loop:          0001          (0=disable 1=enable)
00Kx <cr> Sensor type:          0003          (1=pH Glass 2=pH Antim. 3=ORP)
00Ox <cr> Analog out 4/20mA:    0001          (scale=1-5 for ORP)
00RLx<cr> RT90% large signal  0002 s        (1-20s)
00RSx<cr> RT90% small signal  0010 s        (1-20s)
00Wx <cr> Temp. unit           0001          (1=°C 2=°F)
00Jx <cr> Temp. adjust          not done    0.0        (5.0°C/9.0°F max) (00JR reset)
00Nx <cr> Tman                  20.0 °C    (0.0-100.0°C / 32.0-212.0°F)
00Vx <cr> Standard zero ORP:    0 mV        (-2000+2000 mV)
00Tx <cr> Standard sens.ORP:    0 mV        (-2000+2000 mV)
00Z <cr> Zero calibration:      not done    0          (100 mV max) (00ZR reset zero)
00S <cr> Sens. calibration:      not done   100.0%    (80-110%)   (00SR reset sens)
00Dx <cr> Last cal date:        00/00/00   (XX/XX/XX XX=00-99)
00Ix <cr> ID B&C:              0009          (01-99)
00Ex <cr> ID modbus:           0009          (01-243)
00Bx <cr> Baud rate:           0003          (1=2400 2=4800 3=9600 4=19200)

Type ID number or 00 before command. Example, if ID=15 type 15A or 00A <cr>
Use 00A <cr> if only one probe is connected
Query commands: 00H?,00Z?,00S?,00J?
-----

```

PARAMETERS QUERY

Command format: ID + H? <cr>

Example: if ID=14 type 14H? <cr> or 00H? <cr>

By sending the command H? displays a record containing the code and the identifier followed by all parameters including the results of calibrations.

The record transmitted uses the "," as separator.

Record format:

```

PH3436- 02,FW:3.00,SN:123456,L:0001,K:0001,O:0001,RL:0002,RS:0010,W:00
....+....|....+....|....+....|....+....|....+....|....+....|....+....|
01,J:not done ±  0.0°C ,N: 20.0 °C ,V:  7.00,T:  4.00,Z:not done ±
....+....|....+....|....+....|....+....|....+....|....+....|....+....|
 0.00pH ,S:not done 100.0% ,D:00/00/00,IA:0009,EA:0009,BA:0003,BC
....+....|....+....|....+....|....+....|....+....|....+....|....+....|
C:4BB8,xx

```

PH3436	Transmitter code
02	Transmitter identification number

Below are transmitted parameter values measured by the transmitter with the format NAME PARAMETER: VALUE.

FW:3.00	Firmware version
SN:123456	Transmitter serial number

L:0001	Current loop enable
K:0001	Sensor type
O:0001	Analog output/scale setting
RL:0002	Large software filter value
RS:0010	Small software filter value
W:0001	Temperature measuring unit
J:not done 0.0 °C	Temperature calibration outcome
N:20.0 °C	Manual temperature
V:0.00 pH	Zero standard solution value
T:0.00 pH	Sensitivity standard solution value
Z:not done ±0.00pH	Zero calibration outcome
S:not done 100.0%	Sensitivity calibration outcome
D:00/00/00	Last calibration date
IA:0009	ID B&C protocol
EA:0009	ID Modbus protocol
BA:0003	Baud rate
BCC:4BB8	BCC EEPROM check
xx	2 byte BCC of transmitted record

The record transmission is ended by <cr> <lf>.

EEPROM BCC check use

The EEPROM BCC check is a summary of the transmitter configuration state, the value of the BCC, once set the parameters and carried out the calibration, remains constant until the next change of parameters or calibration. A variation of the BCC value without any change occurred means that an alteration has taken place in transmitter's configuration data.

BCC calculation

The BCC messages sent by the transmitter is calculated as the XOR of all the bytes making up the message (excluding <cr> and <lf>) and divided into 2 nibble.

The two nibbles are then transformed into their ASCII codes.

The BCC transmitted at the end of record is used to check the validity of records received.

ACQUISITION

Command format: ID + A <cr>

]Example: if ID=14 type 14A <cr> or 00A <cr>

By sending the command A, the transmitter responds by sending a record containing the code, the ID, date, time, and the value of all the measures.

Record format

```
(x pH)
PH3436- 10 0.0 01/01/01 00:00:00 ± 10.00pH ± 20.0°C      0stat 18/11/10xx
(x ORP)
PH3436- 10 0.0 01/01/01 00:00:00 ± 1000mV ± 20.0°C      0stat 18/11/10xx
.....+.....|.....+.....|.....+.....|.....+.....|.....+.....|.....+.....|.....+.....|.....+.....
```

PH3436	p/n of the transmitter
10	ID
0.0	Power voltage (not implemented)
01/01/01	Date (not implemented)
00:00:00	Hour (not implemented)

Below are transmitted the parameter values measured by the transmitter with the following format:

Measuring	- Sign of measure (if positive is sent a blank) - Value of measure (6 characters - right alignment)
Measuring unit	- 4 characters - left alignment - 1 blank (ASCII 32)
± 10.00 pH	pH value
± 20.0 °C	Temperature
0stat	Stato - bit 0 logic input: 0 = open; 1 = close - bit 1 hold from keyboard: 0 = no hold; 1 = hold - bit 2 manual temperature: 0 = auto; 1 = manual

At the end of the record the transmitter sends the last calibration date, then 2 bytes containing the BCC of the string sent.

18/11/10	Date of the last calibration
xx	2 byte BCC

The record transmission is ended by <cr> <lf>.

BCC calculation

The BCC messages sent by the transmitter is calculated as the XOR of all the bytes of the message (excluding <cr> and <lf>) and divided into two nibbles.

The two nibbles are then transformed into their ASCII codes.

The BCC transmitted at the end of record is used to check the validity of records received.

CURRENT LOOP

Command format: ID + L + x <cr>

Example: if ID=14 and you want to enable the current loop type 14L0 <cr> or 00L0 <cr>

Response of the unit: <If> ID + L + x <cr> <If> command executed correctly

Response of the unit: none command failed

It is possible to enable or disable the current loop by selecting:

x=0 current loop disabled

x=1 current loop enabled

SENSOR TYPE

Command format: ID + K + x <cr>

Example: if ID=14 and you want to enable the current loop type 14K1 <cr> or 00K1 <cr>

Response of the unit: <If> ID + K + x <cr> <If> command executed correctly

Response of the unit: none command failed

The type of measure can be configured as follows:

x=1 pH measuring with glass electrode

x=2 pH measuring with antimony electrode

x=3 ORP measuring

ANALOG OUTPUT (only for ORP measurement)

Command format: ID + O + x <cr>

Example: if ID=14 and analog out = 1 scale (range 0 to 1000 mV) type 14O1 <cr> or 00O1 <cr>

Response of the unit: <If> ID + O + x <cr> <If> command executed correctly

Response of the unit: none command failed

The 4-20 mA analog output can be assigned to one of the five ORP scales:

x=1 0 ÷ 1000 mV scale

x=2 0 ÷ -1000 mV scale

x=3 -1000 ÷ 1000 mV scale

x=4 0 ÷ 2000 mV scale

x=5 0 ÷ -2000 mV scale

LARGE FILTER

Command format: ID + RL + x <cr>

Example: if ID=14 and the response time is 5 seconds type 14RL5 <cr> or 00RL5 <cr>

Response of the unit: <If> ID + RL + x <cr> <If> command executed correctly

Response of the unit: none command failed

To check whether the entered value has been received type command ID + H.

SMALL FILTER

Command format: ID + RS + x <cr>

Example: if ID=14 and the response time is 5 seconds type 14RS5 <cr> or 00RS5 <cr>

Response of the unit: <lf> ID + RS + x <cr> <lf> command executed correctly

Response of the unit: none command failed

To check whether the entered value has been received type command ID + H.

TEMPERATURE MEASURING UNIT

Command format: ID + W + x <cr>

Example: if ID=14 and the unit of measurement of the temperature is °C type 14W1 <cr> or 00W1 <cr>

Response of the unit: <lf> ID + W + x <cr> <lf> command executed correctly

Response of the unit: none command failed

The temperature measuring unit can be configured with the following values:

x=1 measuring unit °C

x=2 measuring unit °F

TEMPERATURE CALIBRATION

Command format: ID + J + x <cr>

Example: if ID=14 and the temperature value to be taken is 23.2 °C type 14J23.2 <cr> or 00J23.2 <cr>

Response of the unit: <lf> ID + J + x <cr> <lf> command executed correctly

Response of the unit: none command failed

Zero adjustment of the temperature measure.

To verify the results of the temperature correction use the ID + A, the temperature reading should be approx same as the adjusted value.

With the command ID + H control the line "Temp. adjust: ok / error".

With the command ID + J? you can read the result directly.

If the operation has failed (error) the previous zero value is retained.

The "Temp. adjust: not done" message indicates that the parameter has been restored to the default value with the command ID + JR.

TEMPERATURE CALIBRATION RESET

Command format: ID + JR <cr>

Example: if ID=14 type 14JR <cr> or 00JR <cr>

Response of the unit: <lf> ID + JR <cr> <lf> command executed correctly
 Response of the unit: none command failed

This command allows you to return the value of the zero temperature to the default value.

Verify the outcome of the operation with the command ID + H and check the line "Temp. adjust: not done".

TEMPERATURE CALIBRATION TEST

Command format: ID + J? <cr>

Example: if ID=14 type 14J? <cr> or 00J? <cr>

Response of the unit: <8 characters outcome> command executed correctly
 <blank> <7 digit value> <4 characters unit> <cr> <lf>

Response of the unit: none command failed

Record format

```
ok      ±  0.2°C
.....+.....|.....+.....|.....+.....|.....+.....|.....+.....|.....+.....|.....+.....|
```

The possible results are: ok / not done / error.

MANUAL TEMPERATURE

Command format: ID + N + x <cr>

Example: if ID=14 and the manual temperature is 28.3 °C type 14N28.3 <cr> or 00N28.3 <cr>

Response of the unit: <lf> ID + N + x <cr> <lf> command executed correctly
 Response of the unit: none command failed

To check whether the entered value has been received, type command ID + H.

ZERO CALIBRATION SOLUTION VALUE

Command format: ID + V + x <cr>

Example: if ID=14 and the standard solution for zero calibration is 7.02 pH type 14V7.02 <cr> or 00V7.02 <cr> (max. two decimals for pH scale)

In the case of the ORP the command is the same (no decimal figures).

Example: 14V220 <cr>

Response of the unit: <lf> ID + V + x <cr> <lf> command executed correctly
 Response of the unit: none command failed

To check whether the entered value has been received, type command ID + H.

SENSITIVITY CALIBRATION SOLUTION VALUE

Command format: ID + T + x <cr>

Example: if ID=14 and the standard solution for the calibration of the pH sensitivity is 10.00 pH type 14T10.00 <cr> or 00T10.00 <cr> (max. two decimals for pH scale)

In the case of the ORP scale the command is the same (no decimal figures).

Example: 14T468 <cr>

Response of the unit: <lf> ID + T + x <cr> <lf>	command executed corectly
Response of the unit: none	command failed

To check whether the entered value has been received, type command ID + H.

ZERO CALIBRATION

Zero calibration (first calibration point).

The value of the solution should be inserted through the command "Standard zero".

The transmitter adjusts the offset to display the value of the calibration solution.

Calibration to be performed preferably at first installation, before calibration sensitivity.

Command format: ID + Z <cr>

Example: if ID=14 type 14Z <cr> or 00Z <cr>

Response of the unit: <lf> ID + Z <cr> <lf>	command executed correctly
Rspnse of the unit: none	command failed

To verify the results of the zero calibration use the ID + A, the reading should be about the value of the standard solution.

Through the ID + H control the line " Zero calibration: ok / error ".

Through the ID + Z? you can read the result directly.

If the operation has failed (error) the unit will maintain the previous zero value.

The message "Zero calibration: not done" indicates that the parameter has been re-stored to the default value through the command ID + ZR.

ZERO CALIBRATION RESET

Command format: ID + ZR <cr>

Example: if ID=14 type 14ZR <cr> or 00ZR <cr>

Response of the unit: <lf> ID + ZR <cr> <lf>	command executed correctly
Response of the unit: none	command failed

This command returns the zero to the default value.

Verify the outcome of the operation with the ID + H and check the line "Zero calibration: not done".

ZERO CALIBRATION TEST

Command format: ID + Z? <cr>

Example: if ID=14 type 14Z? <cr> or 00Z? <cr>

Response of the unit: <8 characters outcome> command executed correctly
 <blank> <7 digit value> <4 characters unit> <cr> <lf>

Response of the unit: none command failed

Record format

```
ok            ±        0.12pH  
.....+.....|.....+.....|.....+.....|.....+.....|.....+.....|.....+.....|.....+.....|
```

Possible results: ok / not done / error.

SENSITIVITY CALIBRATION

Sensitivity calibration (second calibration point).

The value of the solution should be inserted through the command "Standard sens".

The transmitter adjusts the sensitivity by considering the first calibration point carried out with zero calibration.

The zero is recalculated.

Command format: ID + S <cr>

Example: if ID=14 type 14S <cr> or 00S <cr>

Response of the unit: <lf> ID + S <cr> <lf>

Response of the unit: none

To verify the results of the calibration use the ID + A, the reading should be about the value of the calibration solution.

Through the command ID + S? the user can read the result directly.

Through the command ID + H the user controls the lines lines:

"Zero. calibration: ok / error";

"Sens. calibration: ok / error".

If the operation has failed (error) the unit will maintain the previous d from the previous zero and sensitivity values.

The message "Sens. calibration: not done" indicates that the parameter has been restored to the default value through the command ID + SR.

SENSITIVITY CALIBRATION RESET

Command format: ID + SR <cr>

Example: if ID=14 type 14SR <cr> or 00SR <cr>

Response of the unit: <lf> ID + SR <cr> <lf> command executed correctly

Response of the unit: none command failed

This command allows to return to the default sensitivity value of 100.0 %.
Verify the outcome of the operation through the command ID + H and check the line "Sens. calibration: not done".

SENSITIVITY CALIBRATION TEST

Command format: ID + S? <cr>

Example: if ID=14 type 14S? <cr> or 00S? <cr>

Response of the unit: <8 characters outcome> command executed correctly
 <blank> <7 digit value> <4 characters unit> <cr> <lf>

Response of the unit: none command failed

Record format

```
ok            ± 100.0%  
.....+.....|.....+.....|.....+.....|.....+.....|.....+.....|.....+.....|.....+.....|
```

Possible results: ok / not done / error.

LAST CALIBRATION DATE

Command format: ID + D + XX/XX/XX <cr> (XX = 00 ÷ 99)

Example: if ID=14 and the date to be inserted is 11/05/18 type 14D11/05/18 <cr> or 00D11/05/18 <cr>

Response of the unit: <cr> <lf> ID + D + XX/XX/XX <cr> command executed correctly
 <lf>

Response of the unit: none command failed

This command allows to store the last calibration date.
The date field is 8 characters to be written in the proposed format.

ID OF THE B&C PROTOCOL

Command format: ID + I + x <cr>

Example: if ID=14 and the new ID (identification) to enter is 07 type 14I07 <cr> or 00I07 <cr>

Response of the unit: <lf> ID + I + x <cr> <lf> command executed correctly

Response of the unit: none command failed

The transmitter activates the new ID immediately after the response to the command.

ID OF THE MODBUS PROTOCOL

Command format: ID + E + x <cr>

Example: if ID=14 and the new ID (identification) to enter is 07 type 14E07 <cr> or 00E07 <cr>

Response of the unit: <If> ID + E + x <cr> <If> command executed correctly
Response of the unit: none command failed

The transmitter activates the new ID immediately after the response to the command.

BAUD RATE

Command format: ID + B + x <cr>

Example: if ID=14 and the new speed is 2 = 4800 baud type 14B2 <cr> or 00B2 <cr>

Response of the unit: <If> ID + B + x <cr> <If> command executed correctly
Response of the unit: none command failed

Set the parameter:

x=1 for 2400 baud

x=2 for 4800 baud

x=3 for 9600 baud

x=4 for 19200 baud

The transmitter activates the new ID immediately after the response to the command.

COMMANDS USING ID + SNxxxxxx

From release R3.00 it has been added the possibility to query the transmitters by inserting the serial number of the transmitter in addition to the ID for all the commands provided.

Example: the command to acquire the measurement of a transmitter with ID=14 and SN123456 can be performed with:

interrogation using ID 14A <cr> or 00A <cr>
interrogation using 14SN123456A <cr> or 00SN123456A <cr>
ID+SNxxxxxx

The interrogation with ID + SNxxxxxx becomes a unique command thus allowing to be able to insert more than 99 devices on the network, limit imposed by the commands with ID.

A command is also provided with serial number broadcast ID + SN000000 to which all the transmitters respond.

SEARCH TRANSMITTER TYPE, ID AND SERIAL NUMBER

Command format: ID + SN? <cr>

Example: if the ID is known (ID=14) type 14SN? <cr> to know code and serial number or type 00SN? <cr> to search all the transmitters in the network.

Response of the unit: <6 characters code> <2 characters ID> <6 characters serial number> <2 characters BCC> <cr> <lf> command executed correctly

Response of the unit: none command failed

```
PH3436,14,123456,xx  
.....+.....|.....+.....|
```

This command allows to search all the transmitters in a network.

The transmitters respond by providing their identity: code, ID, serial number.

The transmitter response occurs after a random time chosen by the transmitter itself between 8 time intervals: 0 ms, 200 ms, 400 ms, 600 ms, 800 ms, 1000 ms, 1200 ms, 1400 ms to avoid as much as possible an overlap of the answers when there are more transmitters on the network.

If there are more transmitters, some overlap of communication will be unavoidable.

The master device must manage the transmitters search by disabling the commands of the transmitters it has found, repeating the search command several times until it has found all the transmitters in the network.

At this point the master can re-enable the commands of the transmitters he has found. To disable and re-enable the transmitter commands, see the command ID + SNxxxxxx + MUX <cr>.

The automatic management of transmitters is implemented in the MC 6587 and MC 7687 instruments of the B&C Electronics.

DISABLE/ENABLE COMMANDS USING ID

Command format: ID + SNxxxxxx + MUX <cr>

Example: to disable commands using ID of a transmitter with ID=14 and serial number 123456 type 14SN123456MU1 <cr> or 00SN123456MU1 <cr>

Response of the unit: <cr> <lf> ID + SNxxxxxx + MUX <cr> <lf> command executed correctly

Response of the unit: none command failed

Set parameter:

x=0 to enable commands using ID

x=1 to disable the commands using ID

When the transmitter is disabled to commands using ID:

- can only execute commands with ID + SNxxxxxx;
- does not run the transmitter search command ID + SN?.

6.9.2 MODBUS PROTOCOL

On the transmitter, in addition to the ASCII B&C protocol, is implemented the Modbus RTU protocol limited to the function 03, 06, and 16.

In Modbus communication network the transmitter operates as a slave device.

RTU transmission mode

Coding system	8-bit binary
Number of bits per character:	
- start bits	1
- data bits (minus sign before)	8
- parity	no parity
- stop bits	1
Errors verification	CRC-16

RTU messages format

Pause transmission	duration 3,5 bytes
Address	1 byte (8 bits)
Function	1 byte (8 bits)
Data	N bytes (N x 8 bits)
Errors verification	2 bytes (16 bits)
Pause transmission	duration 3,5 bytes

For a correct synchronization of the transmission the receiving unit interprets the end of a message when it doesn't receive any characters (bytes) for a time equivalent to the transmission of 3.5 characters (bytes).

MODBUS FUNCTION 03 (0x03)

Function 03 (MASTER QUERY)

Address	1 byte	1 ÷ 243 (transmitter ID)
Function	1 byte	03 (read holding register)
Start address data HI	1 byte	Start address of registers
Start address data LO	1 byte	
Number of registers HI	1 byte	Number of registers (2 byte x register)
Number of registers LO	1 byte	
Errors verification	2 bytes	CRC-16

The transmitter considers valid the message if CRC-16 valid, ID valid and function=03.
Function 03 (SLAVE ANSWER)

Address	1 byte	1 ÷ 243 (transmitter ID)
Function	1 byte	03 (read holding register)
Number of byte of sent data	1 byte	2x number of sent registers
N byte of data	N byte	Values of registers
Error verification	2 bytes	CRC-16

If you query requesting registers outside the defined limits, the transmitter answers assigning zero to all of the registers out of range.

If an error occurs in the request, the response takes the following form:

Address	1 byte	1 ÷ 243 (transmitter ID)
Function	1 byte	0x83 (read holding register + error)
Error	1 byte	2 = illegal data address 3 = illegal data value
Error verification	2 bytes	CRC-16

Time between the end of the query and the beginning of the response about 100 ms.

MODBUS FUNCTION 06 (0x06)

Function 06 (MASTER QUERY)

Address	1 byte	1 ÷ 243 (transmitter ID)
Function	1 byte	06 (write single register)
Address data HI	1 byte	Address of the register
Address data LO	1 byte	
Value of the register HI	1 byte	Value to be written
Value of the register LO	1 byte	
Errors verification	2 bytes	CRC-16

The transmitter considers valid the message if CRC-16 valid, ID valid and function=06.
Function 06 (SLAVE ANSWER)

Address	1 byte	1 ÷ 243 (transmitter ID)
Function	1 byte	06 (write single register)
Address data HI	1 byte	Address of the register
Address data LO	1 byte	
Value of the register HI	1 byte	Value to be written
Value of the register LO	1 byte	
Errors verification	2 bytes	CRC-16

When writing some calibration commands (eg zero calibration), the transmitter responds to the request and then remains silent for the time necessary to perform the operation.

If an error occurs in the request, the response takes the following form:

Address	1 byte	1 ÷ 243 (transmitter ID)
Function	1 byte	0x86 (write single register + error)
Error	1 byte	2 = illegal data address 4 = slave device failure
Error verification	2 bytes	CRC-16

Time between the end of the query and the beginning of the response about 100 ms.

MODBUS FUNCTION 16 (0x10)

Function 16 (MASTER QUERY)

Address	1 byte	1 ÷ 243 (transmitter ID)
Function	1 byte	16 (write multiple registers)
Start address data HI	1 byte	Start address of registers
Start address data LO	1 byte	
Number of registers HI	1 byte	Number of registers (2 byte x register)
Number of registers LO	1 byte	
Number of byte	1 byte	2 byte per register
Value of registers	n byte	n = 2 byte x number of registers
Errors verification	2 bytes	CRC-16

The transmitter considers valid the message if CRC-16 valid, ID valid and function=16.

Function 16 (SLAVE ANSWER)

Address	1 byte	1 ÷ 243 (transmitter ID)
Function	1 byte	16 (write multiple registers)
Start address data HI	1 byte	Start address of registers
Start address data LO	1 byte	
Number of registers HI	1 byte	Number of registers (2 byte x register)
Number of registers LO	1 byte	
Errors verification	2 bytes	CRC-16

When writing some calibration commands (eg zero calibration), the transmitter responds to the request and then remains silent for the time necessary to perform the operation.

If an error occurs in the request, the response takes the following form:

Address	1 byte	1 ÷ 243 (transmitter ID)
Function	1 byte	0x90 (write multiple registers + error)
Error	1 byte	2 = illegal data address 3 = illegal data value 4 = slave device failure
Error verification	2 bytes	CRC-16

Time between the end of the query and the beginning of the response about 100 ms.

BROADCAST COMMANDS

Modbus 06 and 16 queries can be made by the master in broadcast mode.

The broadcast mode consists in sending the message with the identifier 0, all the transmitters perceive the message and execute the command but do not respond to the master in order not to create conflicts.

MODBUS REGISTERS

MEASURE AND STATE (address 0x00xx)

	Mod-bus address	Parameter	Range	Unit	Scale	Data type	R/W
1	0x0000	pH	-100 ÷ 1500	0.01 pH	0.00 ÷ 14.00 pH	IS	R
2	0x0001	ORP	-2100 ÷ 2100	1 mV	a	IS	R
3	0x0002	Temperature °C	-100 ÷ 1100	0.1 °C	-10.0 ÷ 110.0 °C	IS	R
4	0x0003	Temperature °F	140 ÷ 2300	0.1 °F	-14.0 ÷ 230.0 °F	IS	R
5	0x0004	Scale	0 ÷ 5	1	b	IS	R
6	0x0005	State: Dig. Inp. Keyb. lock Man. temp.	0/1 0/1 0/1	1 bit0 bit1 bit2	open/close no hold/hold auto/man	I	R
7	0x0006	BCC EEPROM	0 ÷ 65535	1	0 ÷ 65535	I	R

^a = unit and scale depend on what is set in configuration (see 5 and 6)

^b = see chapter "Configuration (page 31)"

IS = integer signed / I = integer

R = read / W = write

ZERO CALIBRATION (address 0x010x)

	Mod-bus address	Parameter	Range	Unit	Scale	Data type	R/W
8	0x0101	Standard zero	0 ÷ 1400 -2000 ÷ 2000	0.01 1	0.00 ÷ 14.00 pH -2000 ÷ 2000 mV	IS	R/W
9	0x0102	Zero command/flag - zero cal - reset zero - flag zero cal	0x5A00 0x5A52 0 = not done 1 = ok 2 = error	1 1 1		IS	W W R
10	0x0103	Zero value	-200 ÷ 200 -100 ÷ 100	0.01 1	-2.00 ÷ 2.00 pH -100 ÷ 100 mV	IS	R

IS = integer signed / I = integer

R = read / W = write

SENSIBILITY CALIBRATION (address 0x011x)

	Mod-bus address	Parameter	Range	Unit	Scale	Data type	R/W
11	0x0113	Standard sens	0 ÷ 1400 -2000 ÷ 2000	0.01 1	0.00 ÷ 14.00 -2000 ÷ 2000	IS	R/W
12	0x0114	Sens command/flag - sens cal - reset sens - flag sens cal	0x5300 0x5352 0 = not done 1 = ok 2 = error	1 1 1		IS	W W R
13	0x0115	Sens value glass pH/redox pH antimonio	800 ÷ 1100 700 ÷ 1400	0.1 0.1	80.0 ÷ 110.0 % 70.0 ÷ 140.0 %	IS	R

IS = integer signed / I = integer

R = read / W = write

TEMPERATURE CALIBRATION (address 0x012x)

	Mod-bus address	Parameter	Range	Unit	Scale	Data type	R/W
20	0x0120	Temp command/flag - reset temp - flag temp cal	0x4A52 0 = not done 1 = ok 2 = error	1 1		IS	W R
21	0x0121	Temp. adj Temp zero value	-100 ÷ 1100 -140 ÷ 2300 -50 ÷ 50 -90 ÷ 90	0.1 0.1 0.1 0.1	-10.0 ÷ 110.0 °C -14.0 ÷ 230.0 °F -5.0 ÷ 5.0 °C -9.0 ÷ 9.0 °F	IS	W R

IS = integer signed / I = integer

R = read / W = write

SETUP (address 0x020x)

	Mod-bus address	Parameter	Range	Unit	Scale	Data type	R/W
16	0x0200	Large filter	1 ÷ 20	1	1 ÷ 20 s	IS	R/W
17	0x0201	Small filter	1 ÷ 20	1	1 ÷ 20 s	IS	R/W

IS = integer signed / I = integer

R = read / W = write

PH 3436 SETUP (address 0x021x)

	Mod-bus address	Parameter	Range	Unit	Scale	Data type	R/W
18	0X0210	Temp unit	1 ÷ 2	1	1 = °C 2 = °F	IS	R/W
19	0x0211	Temp man	0 ÷ 1000 320 ÷ 2120	0.1	0.0 ÷ 100.0 °C 32.0 ÷ 212.0 °F	IS	R/W

IS = integer signed / I = integer

R = read / W = write

CONFIGURATION (address 0x030x)

	Mod-bus address	Parameter	Range	Unit	Scale	Data type	R/W
20	0x0300	Current loop	0 ÷ 1	1	0 = disable 1 = enable	IS	R/W
21	0x0301	Measure and sensor type	1 ÷ 3	1	1 = pH glass 1 = pH antimony 3 = redox	IS	R/W
22	0x0302	NOT USED					
23	0x0303	Baud rate	1 ÷ 4	1	1 = 2400 2 = 4800 3 = 9600 4 = 19200	IS	R/W
24	0x0304	ID B&C	1 ÷ 99	1		IS	R/W
25	0x0305	ID Modbus RTU	1 ÷ 243	1		IS	R/W

IS = integer signed / I = integer

R = read / W = write

PH 3436 CONFIGURATION (address 0x030x)

	Mod-bus address	Parameter	Range	Unit	Scale	Data type	R/W
26	0x0310	ORP Scale	1 ÷ 5	1	1 = 0 ÷ 1000 mV 2 = 0 ÷ -1000 mV 3 = -1000 ÷ 1000 mV 4 = 0 ÷ 2000 mV 5 = 0 ÷ -2000 mV	IS	R/W

IS = integer signed / I = integer

R = read / W = write

INFO TRANSMITTER (address 0x040x)

	Mod-bus address	Parameter	Range	Unit	Scale	Data type	R/W
27	0x0401	Code	6 characters			I	R
28	0x0404	Serial number	6 characters			I	R
29	0x0407	Rev. fw	4 characters			I	R
30	0x0409	Last cal date (1)	00 ÷ 99	1		IS	R/W
31	0x040A	Last cal date (2)	00 ÷ 99	1		IS	R/W
32	0x040B	Last cal date (3)	00 ÷ 99	1		IS	R/W

IS = integer signed / I = integer

R = read / W = write

Use of BCC EEPROM

The EEPROM BCC check is the transmitter configuration state synthesis. After setting the parameters and carry out the calibration the value of the BCC remains constant until the next change of parameters or calibration.

A variation of BCC in the absence of changes warns that an alteration has taken place in the transmitter configuration data.

7 INSTALLATION DRAWINGS

7.1 CONNECTIONS

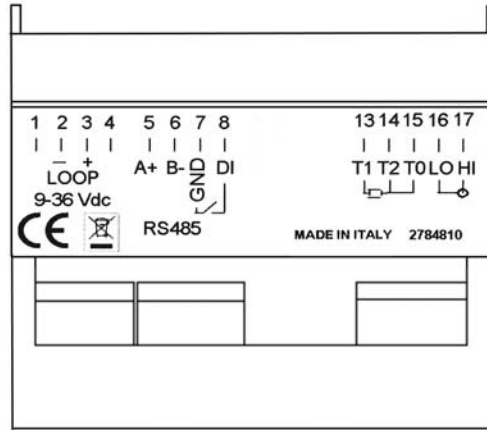

Terminal	Function
2	- Loop
3	+ Loop (9 ÷ 36 Vdc)
5	RS485 A (+)
6	RS485 B (-)
7	RS485 Gnd
7	Digital input
8	Digital input
13	Temperature sensor input
14	Common temperature sensor input
15	Common temperature sensor input
16	pH/ORP reference sensor input
17	pH/ORP sensor input

7.2 DIMENSIONS

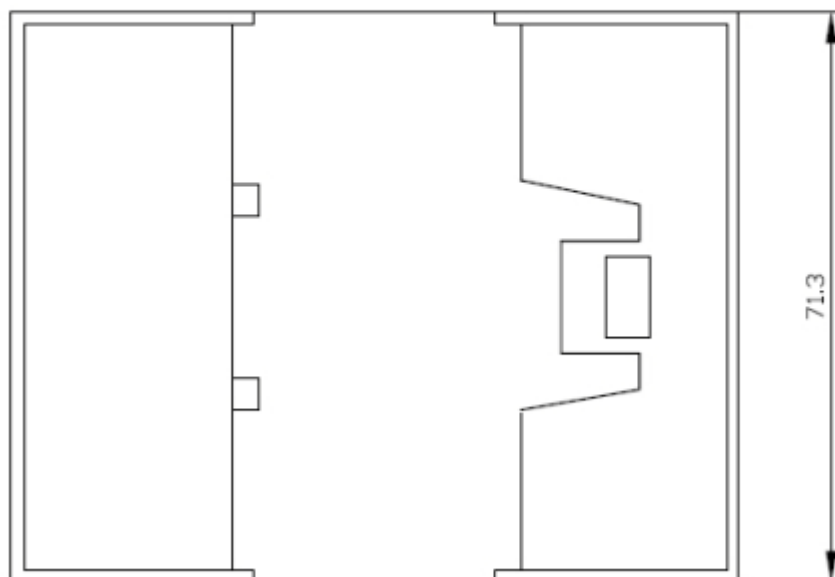
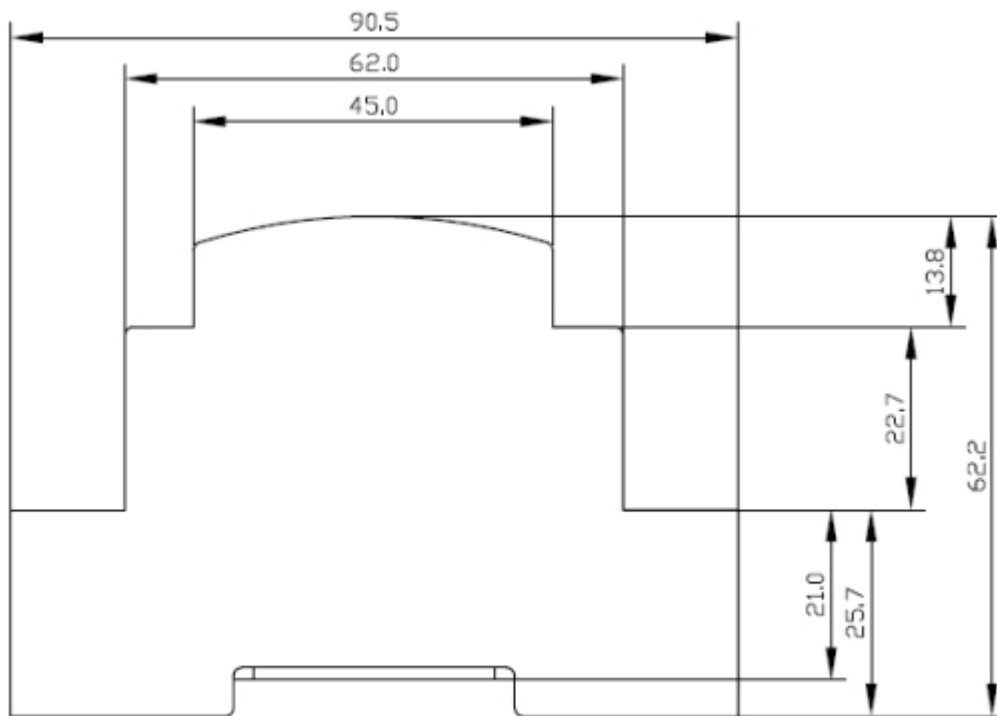

7.3 ANALOG MODE WIRING

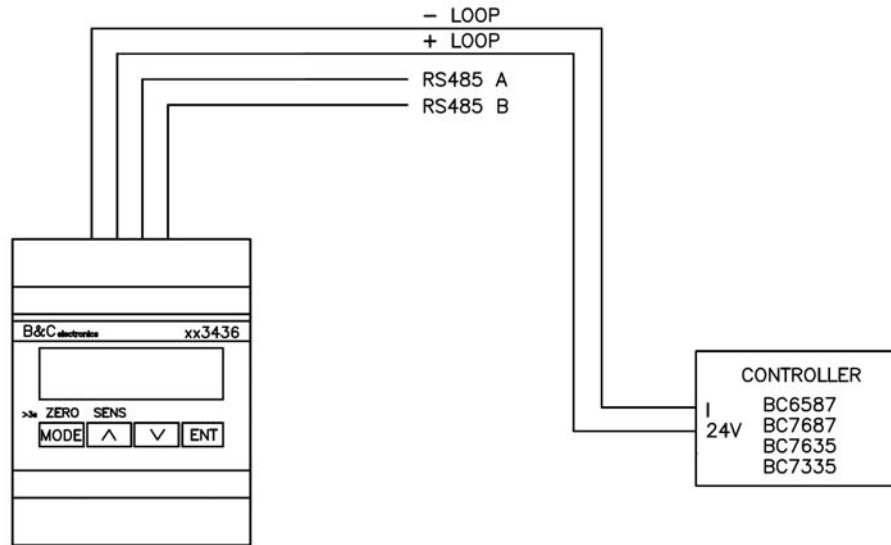

Connection to B&C Electronics' instruments

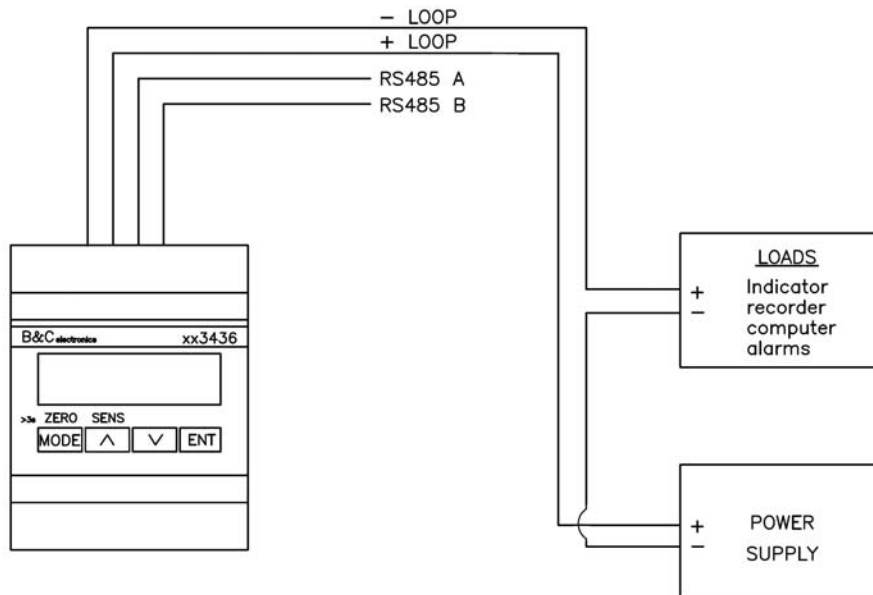

Connection to PLC or data logger

7.4 DIGITAL MODE WIRING

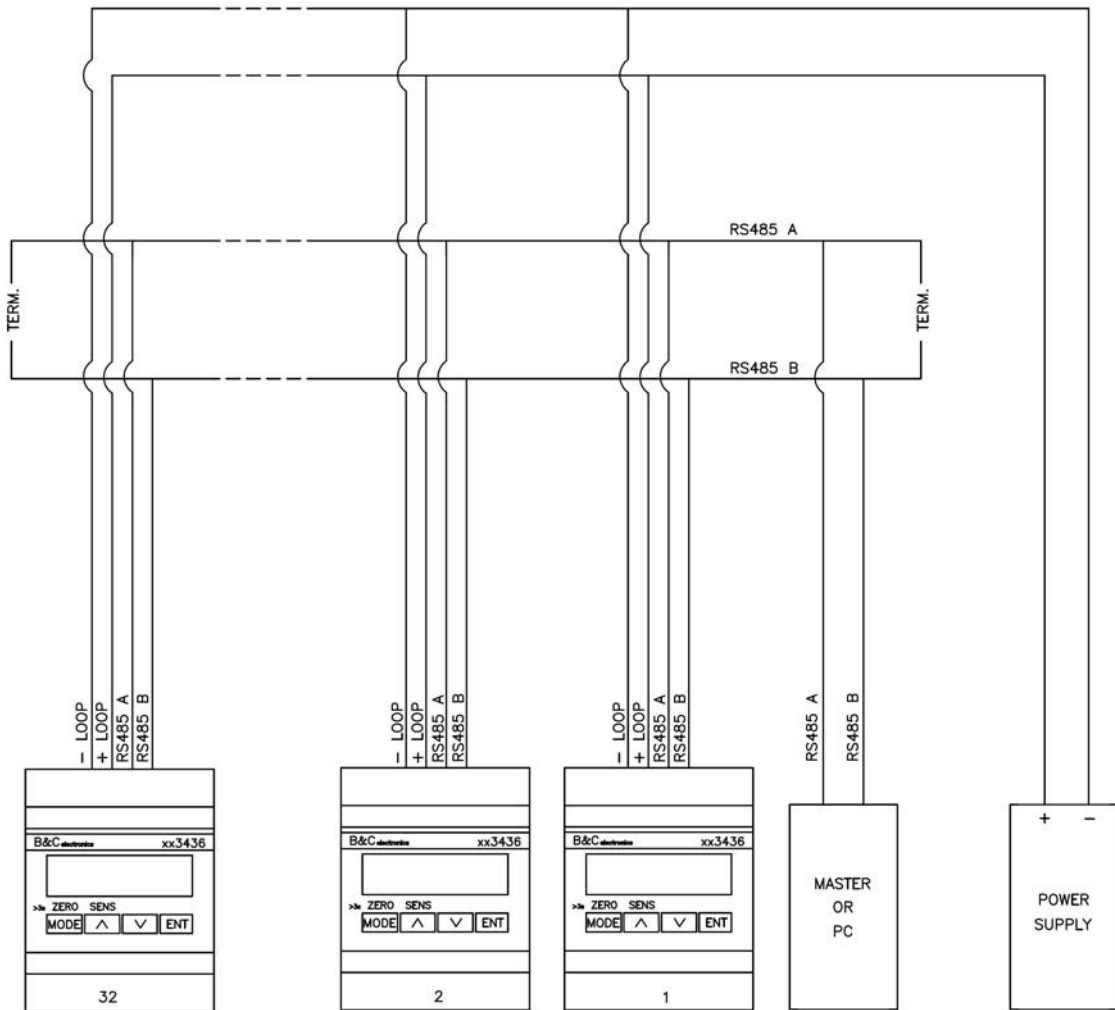

8 WARRANTY

- 1 Your product is guaranteed for 5 years from the date of purchase, for failure due to manufacturing defects.
 - 2 The warranty is void in case of tampering or deterioration due to improper installation or maintenance.
 - 3 The warranty covers only free repair at the laboratories of the manufacturer.
 - 4 B&C Electronics is not liable for any damage arising from misusing its instruments and products.
-

9 REPAIRS

For faster and efficient service it is recommended to fill in the "Information card" for the repair service and attach it to a "Repair order".

- 1 The estimated cost, if required by the customer, is free if the repair is confirmed. Otherwise flat rate results in a charge for the analytical work performed and expenses incurred.
- 2 The products to be repaired must be sent to B&C Electronics with freight prepaid. Any expenses incurred on behalf of the client and not previously agreed will be charged.
- 3 Our sales department will submit to the customer the repair estimate or offer a replacement in the following cases:
 - repair cost is considered excessive in relation to the cost of the product;
 - the repair is technically impossible or unreliable.
- 4 In order to reduce the time of delivery of the repaired products, unless otherwise offered or arranged by the customer, the shipment will be made with ex-factory, prepaid carriage by a courier.

INFORMATION SHEET
for service repairs

In the event of a fault, we recommend you contact our repair service, to photocopy and complete this information sheet to be attached to the product to be repaired.

ESTIMATE

REPAIR

COMPANY NAME

ADDRESS

ZIP

TOWN

REFER TO MR/MRS

TELEPHONE

MODEL

S/N

DATE

Consult the instruction manual to identify the area of the defect and/or describe it:

SENSOR

ANALOG OUTPT

POWER SUPPLY

SET POINT

CALIBRATION

RELAYS CONTACTS

DISPLAY

INTERMITTENT PROBLEM

DESCRIPTION OF THE DEFECT

.

.

.

.

.

.



B&C Electronics s.r.l. – Via per Villanova 3 – 20866 Carnate (MB) – Italia
Tel. +39 039 631 721 – Fax +39 039 607 6099 – bc@bc-electronics.it – www.bc-electronics.it